

# *Daytona*

AUTOMOTIVE EQUIPMENT

## LTPF9 Single side manual unlock two-post lift User Manual

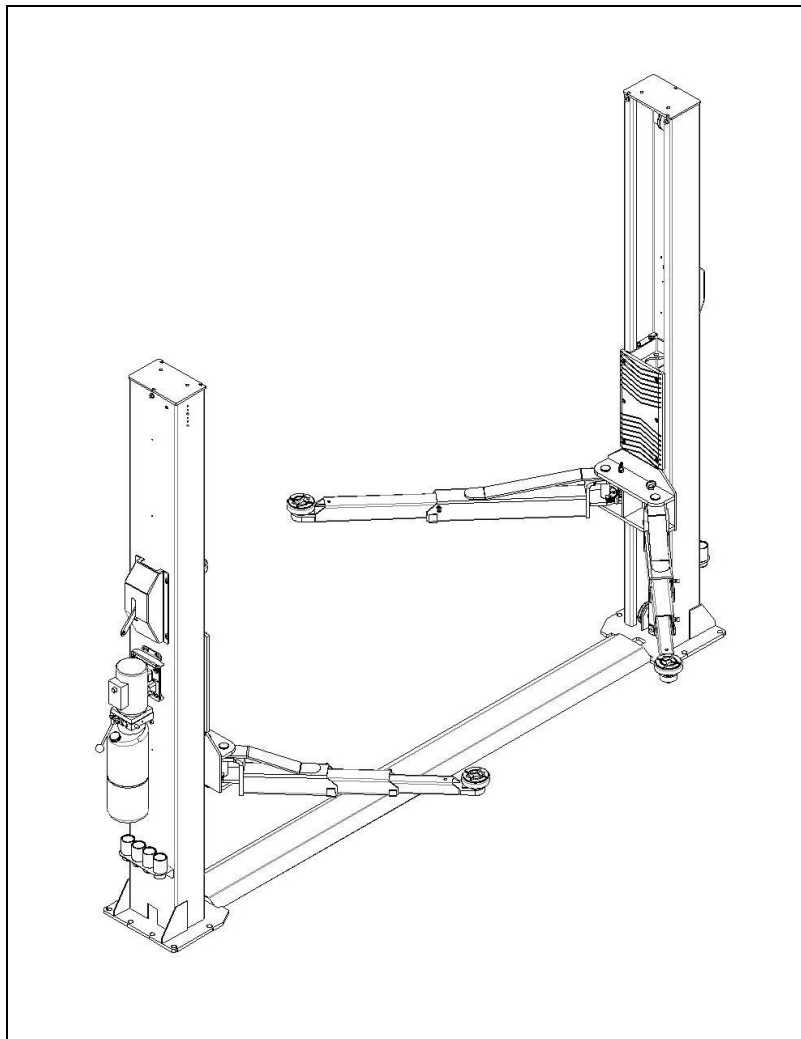

Serial No. \_\_\_\_\_





# AUTHORIZATION TO MARK

This authorizes the application of the Certification Mark(s) shown below to the models described in the Product(s) Covered section when made in accordance with the conditions set forth in the Certification Agreement and Listing Report. This authorization also applies to multiple listee model(s) identified on the correlation page of the Listing Report.

This document is the property of Intertek Testing Services and is not transferable. The certification mark(s) may be applied only at the location of the Party Authorized To Apply Mark.

<b>Applicant:</b>	YangZhou HuaSheng Motors Manufacturing Co., Ltd	<b>Manufacturer:</b>	YangZhou HuaSheng Motors Manufacturing Co., Ltd
<b>Address:</b>	88# North FeiDa Road, XieJia Town, GaoYou City JiangSu, China	<b>Address:</b>	88# North FeiDa Road, XieJia Town, GaoYou City JiangSu, China
<b>Country:</b>	China	<b>Country:</b>	China
<b>Contact:</b>	Mr. Mao Qun Dai	<b>Contact:</b>	Mr. Mao Qun Dai
<b>Phone:</b>	86-514-84738899	<b>Phone:</b>	86-514-84738899
<b>FAX:</b>	86-514-8473858	<b>FAX:</b>	86-514-8473858
<b>Email:</b>	18952558588@189.com	<b>Email:</b>	18952558588@189.com

**Party Authorized To Apply Mark:** Same as Manufacturer  
**Report Issuing Office:** Intertek Testing Services Shenzhen Ltd. Guangzhou Branch.

**Control Number:** 3191617

**Authorized by:**   
 Thomas J. Patterson, Certification Manager



This document supersedes all previous Authorizations to Mark for the noted Report Number.

This Authorization to Mark is for the exclusive use of Intertek's Client and is provided pursuant to the Certification agreement between Intertek and its Client. Intertek's responsibility and liability are limited to the terms and conditions of the agreement. Intertek assumes no liability to any party other than to the Client in accordance with the agreement, for any loss, expense or damage occasioned by the use of this Authorization to Mark. Only the Client is authorized to permit copying or distribution of this Authorization to Mark and then only in its entirety. Use of Intertek's Certification mark is restricted to the conditions laid out in the agreement and in this Authorization to Mark. Any further use of the Intertek name for the sale or advertisement of the tested material, product or service must first be approved in writing by Intertek. Initial Factory Assessments and Follow up Services are for the purpose of assuring appropriate usage of the Certification mark in accordance with the agreement, they are not for the purposes of production quality control and do not relieve the Client of their obligations in this respect.

Intertek Testing Services NA Inc.  
 545 East Algonquin Road, Arlington Heights, IL 60005  
 Telephone 800-345-3851 or 847-439-5667 Fax 312-283-1672

<b>Standard(s):</b>	Rotating Electrical Machines – General Requirements - UL1004-1, 2nd Ed., Rev. Sep. 27, 2013 Motors and Generators - CSA C22.2 No.100-04 (R2013)
<b>Product:</b>	Hydraulic AC Motor
<b>Models:</b>	YL90GA-2, YL90GB-2

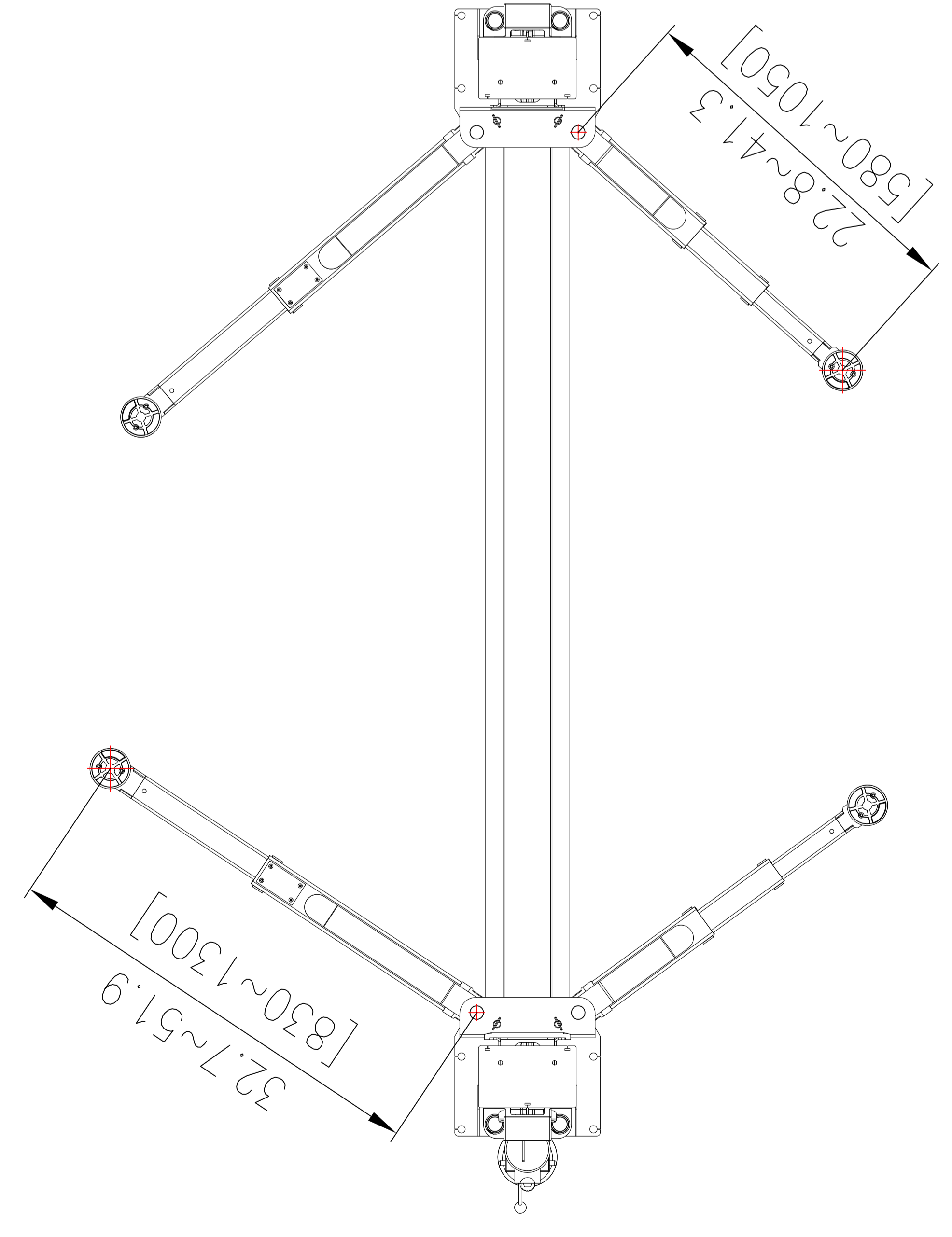
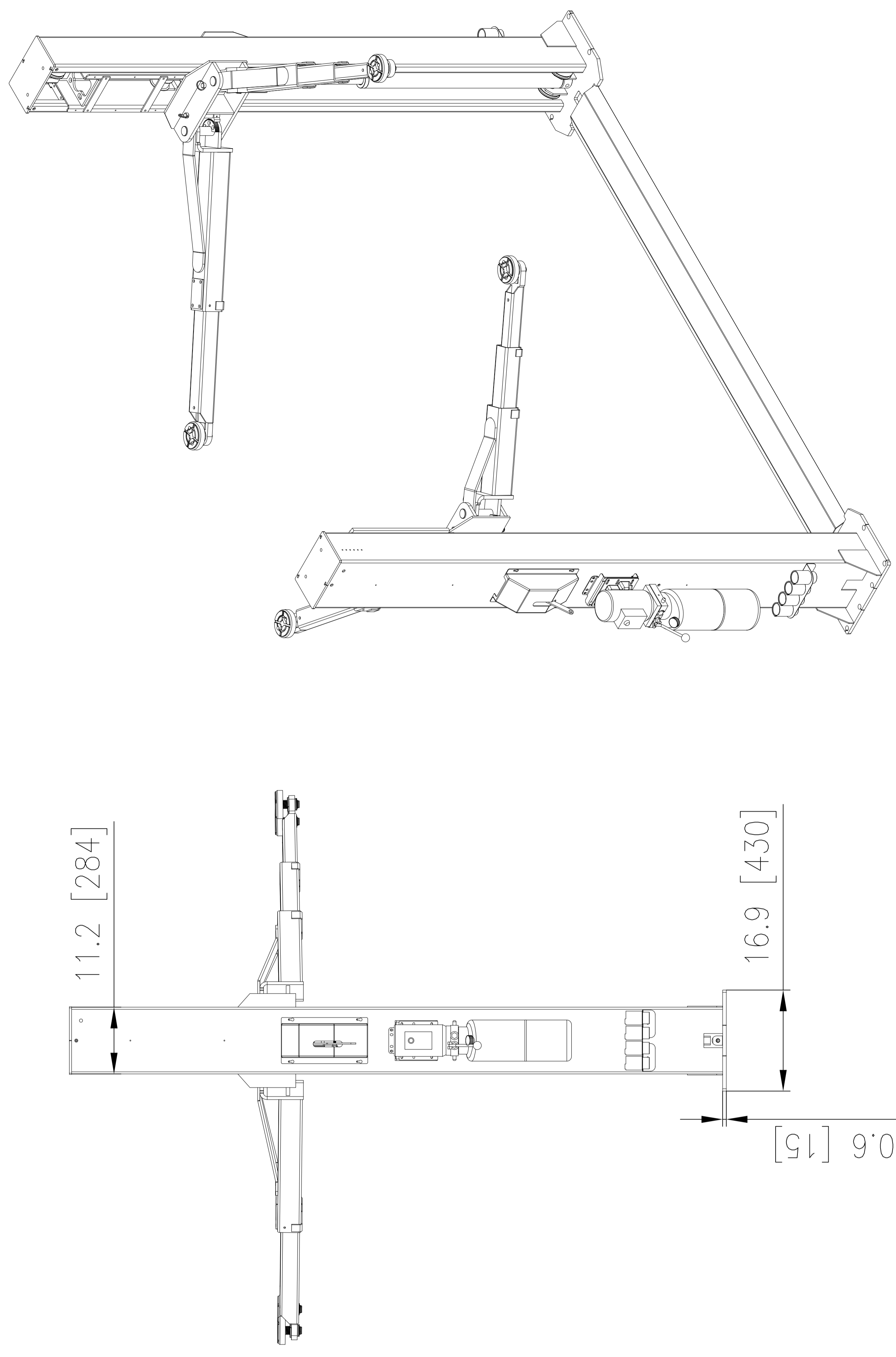
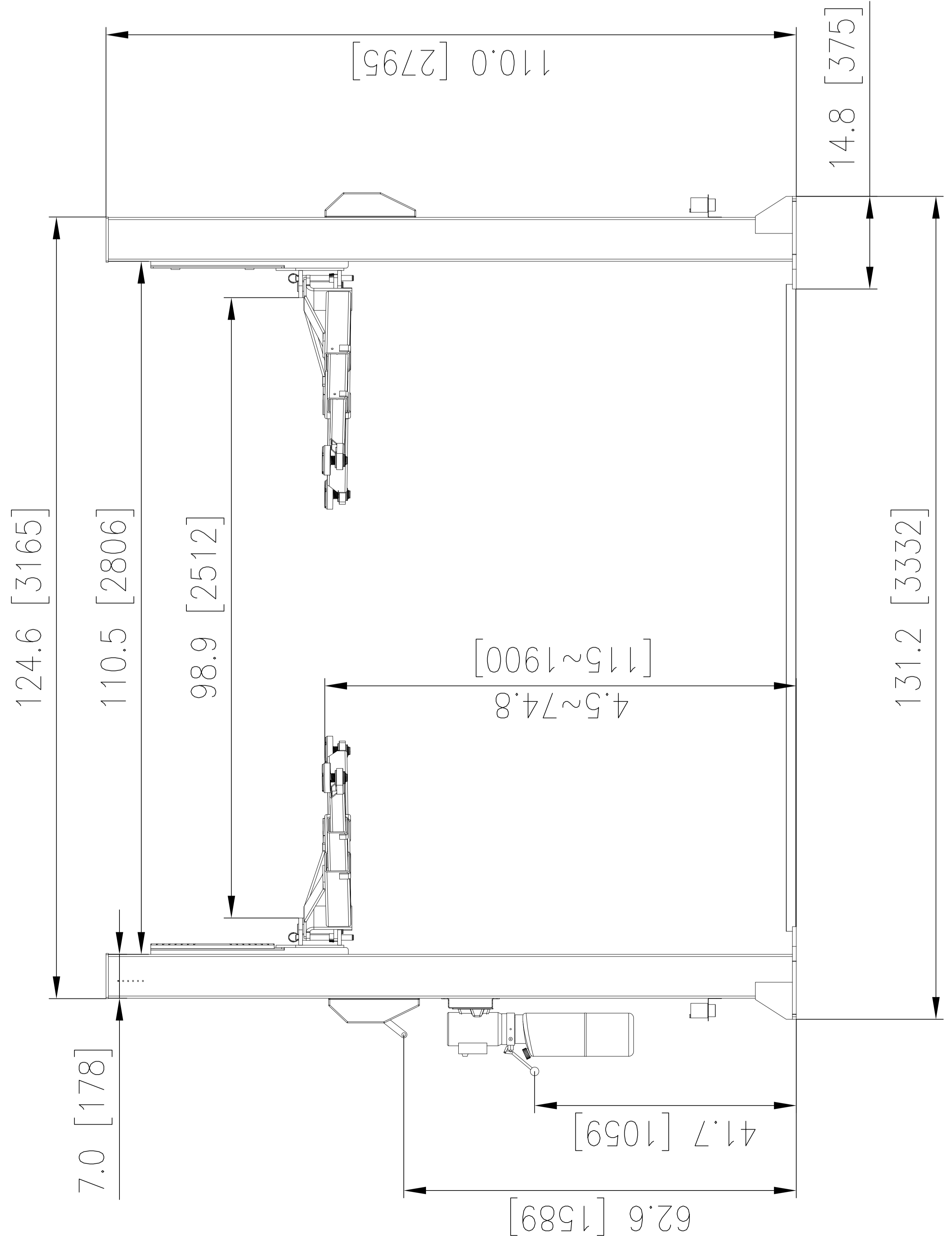

**Daytona**  
AUTOMOTIVE EQUIPMENT

LTPF9

9000 1bs TWO-POST FLOORPLATE LIFT

APPROVED FOR PRODUCTION  
 Certified Engineer: *Ruiyong Li*  
 Cert.No.: B093201001233320001  
 Date: 15.04.2024



## **Safety Information for 2-Post Lifts**

### **I. INSTALLATION, OPERATION, and MAINTANENCE**

#### **Vertical clearance**

- Check the height of the area where the lift is to be installed.
- Clearance should be calculated based on the full raised height of the lift.
- Failure by purchaser to provide adequate clearance could result in unsatisfactory lift performance, property damage, or personal injury.

#### **Flooring**

- Be certain you have the proper concrete floor to properly handle the loaded lift.
- Floor should be in generally good condition with no large cracks, spalling or deterioration.
- The MINIMUM requirements for concrete floors are **4 inches of depth**, with steel reinforcement, 3500 psi, cured for 28 days per local commercial practice.
- The floor should be level within 3/8 inch over the installation area.
- No anchors should be installed within **6 inches** of any crack, edge, or expansion joint.
- If these conditions cannot be met, a pad may be poured to accommodate the lift.
- Check with local building inspectors and/or permits office for any special instructions or approvals required for your installation.
- Failure by purchaser to provide the recommended mounting surface could result in unsatisfactory lift performance, property damage, or personal injury.

#### **Location**

- This lift has been evaluated for indoor use only with an operating ambient temp. range of 5 – 40°C (41– 104°F)

#### **Electrical requirements**

- Refer to Electrical Wiring Diagram found in user manual.

#### **Safety notices and decals**

- For your safety, and the safety of others, read and understand all of the safety notices and decals included here.
- READ ENTIRE MANUAL BEFORE ASSEMBLING, INSTALLING, OPERATING, OR SERVICING THIS EQUIPMENT. PROPER MAINTENANCE AND INSPECTION IS NECESSARY FOR SAFE OPERATION. DO NOT OPERATE A DAMAGED LIFT.

- Safety decals similar to those shown here are found on a properly installed lift.
- Be sure that all safety decals have been correctly installed on the columns as described in this installation manual.
- Verify that all authorized operators know the location of these decals and fully understand their meaning.
- Replace worn, faded, or damaged decals promptly.
- Do not attempt to raise a vehicle on the lift until the lift has been correctly installed and adjusted as described in this manual.

## II. **OPERATION PROCEDURE SAFETY NOTICES AND DECALS**

This product is furnished with graphic safety warning labels. Do not remove or deface these warning labels, or allow them to be removed or defaced. For your safety, and the safety of others, read and understand all of the safety notices and decals included.

## III. **OWNER/EMPLOYER RESPONSIBILITIES**

The Owner/Employer shall ensure that lift operators are qualified and that they are trained in the safe use and operation of the lift using the manufacturer's operating instructions. The Owner/Employer shall establish procedures to periodically inspect the lift in accordance with the lift manufacturer's instructions.

### **Inspection and Maintenance**

The employer shall ensure that the lift inspectors are qualified and that they are adequately trained in the inspection of the lift. The Owner/Employer shall establish procedures to periodically maintain the lift in accordance with the lift manufacturer's instructions and the employer shall ensure that the lift maintenance personnel are qualified and that they are adequately trained in the maintenance of the lift. The Owner/Employer shall maintain the periodic inspection and maintenance records recommended by the manufacturer.

## IV. **IMPORTANT SAFETY INSTRUCTIONS**

When using your garage equipment, basic safety precautions should always be followed, including the following:

- 1) Read all instructions.
- 2) Care must be taken as burns can occur from touching hot parts.
- 3) To reduce the risk of fire, do not operate equipment in the vicinity of open containers of flammable liquids (gasoline).
- 4) Keep hair, loose clothing, fingers, and all parts of body away from moving parts.
- 5) Use only as described in this manual. Use only manufacturer's recommended attachments.
- 6) ALWAYS WEAR PERSONAL PROTECTIVE EQUIPMENT. Everyday eyeglasses only have impact resistant lenses, they are not safety glasses.

SAVE THESE INSTRUCTIONS

### **Lifting a Vehicle**

- 1) Ensure that the lifting arms are parked, out to full drive through position.
- 2) Center the vehicle between the columns in the service bay and position the vehicle's center of gravity midpoint between the columns.
- 3) NOTE: the center of gravity is based on the weight distribution and is not the same as the center point of the vehicle.
- 4) DO NOT EXCEED **2500 POUNDS** PER ARM. DO NOT ATTEMPT TO LIFT THE VEHICLE WITH ONLY TWO ARMS, AS THIS WILL VOID THE WARRANTY ENSURE THAT THE HIGHEST POINT ON THE VEHICLE WILL CONTACT THE OVERHEAD LIMIT SWITCH BAR.
- 5) DO NOT PLACE THE VEHICLE IN THE SERVICE BAY BACKWARDS. REFER TO THE VEHICLE MANUFACTURERS SERVICE MANUAL, TECHNICAL BULLETINS, "VEHICLE LIFTING POINTS GUIDE" OR OTHER PUBLICATIONS TO LOCATE THE RECOMMENDED LIFTING POINTS.
- 6) Position the arms and adapters so all four pads contact the vehicle simultaneously. The vehicle should remain level during lifting.
- 7) Raise the lift until all four wheels are off the ground. Test the stability of the vehicle by attempting to rock the vehicle. Check adapters for secure contact with vehicle lift points. If the vehicle seems unstable, lower the lift and readjust the arms. If the vehicle is stable, raise the vehicle to a height a few inches above the desired working height.
- 8) Lower the vehicle until the safety latches on both columns engage. The vehicle should remain level when both latches are engaged. If one side engages and the other continues to descend, stop lowering the vehicle, raise it several inches, and try again to engage both latches. Always lower lift into locks before entering the area beneath the vehicle. Always use safety stands when removing or installing heavy components.

### **Lowering a Vehicle**

- 1) Ensure that the area under the vehicle is clear of personnel and tools.
- 2) Raise the vehicle until both latches are free.
- 3) Disengage the latches by pulling down and holding the lock release lever.
- 4) Lower the vehicle by depressing the lowering valve handle.
- 5) Continue to lower the vehicle until the carriages stop against the base plate. Retract the extension arms, and park them.
- 6) Loss of Power: If for any reason the lift will not rise off the locks or the locks will not retract, consult factory authorized personnel. DO NOT OVERRIDE ANY SAFETY FEATURE IN AN ATTEMPT TO LOWER THE LIFT.

## **V. MAINTENANCE**

To avoid personal injury, permit only qualified personnel to perform maintenance on this equipment. Maintenance personnel should follow lockout/tagout instructions per ANSI

Z244.1. The following maintenance points are suggested as the basis of a routine maintenance program. The actual maintenance program should be tailored to the installation. If lift stops short of full rise or chatters, check fluid level and bleed both cylinders per Installation Instructions. Replace all Safety, Warning or Caution Labels if missing or damaged.

### **Daily**

- Keep lift components clean.
- Check for loose or broken parts.
- Check hydraulic system for fluid leaks.
- Check arm stop hardware and engagement by fully extending each arm. If arm stop hardware is loose, tighten hardware until spring lock washer is fully compressed.
- Check adapters for damage or excessive wear. Replace as required with genuine Daytona parts.
- Check lock release activation. When properly adjusted, the idler column lock should rest firmly against the back of the column when engaged and pull clear of the column back when disengaged.
- Weekly check synchronizer cables and sheaves for wear. Replace as required with genuine Snap On parts.
- Check lock release cable function per final adjustment instructions.
- IMPORTANT: IF IDLER SIDE LOCK PAWL DOES NOT FULLY DISENGAGE, DAMAGE MAY RESULT TO IDLER SIDE CARRIAGE AND OR CABLE SYNCHRONIZING SYSTEM.
- Check synchronizer cable tension per final adjustment instructions. Adjust if necessary.

### **Monthly**

- Torque concrete anchor bolts to 80 ft-lbs.
- Check overhead shutoff switch. While raising lift, operate overhead shutoff bar. Power Unit motor should stop when bar is raised.
- Lubricate carriage slide tracks with heavy viscous grease. (Grease all (4) corners of both columns.)
- Visually inspect concrete floor for cracks and/or spalls within 12" of base plate. If any problems are encountered, contact your local service representative.

For further information or assistance, please reach out to Daytona Automotive Equipment at 613-475-5400, or toll free at 1-866-219-9991

# Contents

1. Safety precautions....	1
2. Features of the lift...	2
3. Main technical parameters of the lift...	3
4. Lifting machine dimensions....	3
5. Lifting machine foundation size.....	4
6. Lifting machine structure and working principle.....	5
7. Lifting machine installation and debugging.....	6
8. Lifting machine operation instructions.....	15
9. Lifting machine maintenance and upkeep.....	17
10. Noise declaration.....	22
11. Lifting machine breakdown diagram and details.....	23
12. Faults and troubleshooting methods.....	36

## **1 Safety precautions**

- 1.1 After receiving the whole machine, count the number of the whole machine structure before installing the machine.**
- 1.2 Before using the equipment, please read this manual carefully. It is strictly prohibited for those who have not read this manual to operate the lift.**
- 1.3 Installation and debugging personnel must have certain mechanical and electrical knowledge.**
- 1.4 Lifts should be installed in a sufficiently large space to facilitate unrestricted operation and have a safe distance.**
- 1.5 The lift must be installed on the ground with sufficient strength, and can not be installed on loose and brittle surfaces such as asphalt and tile, or on concrete with large defects.**
- 1.6 Lifting machine should not be installed near heating, air conditioning, water source, stove, gas humidifier and other facilities.**
- 1.7 Lifting machine should not be installed in an environment with a large amount of dust, chemicals and other corrosive media.**
- 1.8 Before installation, check whether the power supply is consistent with the identification on this manual and the nameplate of the lift.**
- 1.9 Installation on the ground floor of an upper or basement level is not permitted without permission from the construction department.**
- 1.10 The pre-burial and other forms of power connection of the conduit must comply with the relevant wire installation regulations.**
- 1.11 Before work, remove obstacles around and below the platform.**
- 1.12 When lifting, no one can stand on the left and right side of the lift, and no one can ride in the car being lifted.**
- 1.13 The weight of the lifted vehicle shall not exceed the lifting capacity of the machine.**
- 1.14 When the lift is not in use, the power supply should be cut off.**
- 1.15 The machine should be maintained strictly according to this manual, and the main parts should be carefully checked and maintained frequently.**
- 1.16 Fire extinguishers and other fire prevention devices shall be provided on the site of equipment use (user's own).**
- 1.17 Before the vehicle is ready to go up to the car position, spread the four support arms first to ensure that there are no obstacles in the vehicle passage. Do not kick the support arms with your feet, which will damage the teeth of the support arms.**
- 1.18 Before lifting the vehicle, ensure that all rocker arm teeth are successfully engaged.**
- 1.19 Four support arms must be used to lift the vehicle at the same time. It is prohibited to use less than four support arms to lift the vehicle.**
- 1.20 After lifting the vehicle, the mechanical lock must be executed. It is prohibited to work under the vehicle without mechanical lock.**
- 1.21 Before the vehicle leaves the lift, swing the support arm back to the initial position to ensure that there is no interference with the vehicle.**
- 1.22 The short support arm is installed at the front and the long support arm is**

installed at the rear. (Generally, the car has a front engine)

**1.23 The safety rope must be firm. When pulling the safety handle, the main and auxiliary pillar safety blocks must be fully opened simultaneously.**

**Note: The safety warnings and instructions in this manual do not cover all possible situations. Operators should have sufficient safety knowledge.**

## **2. Characteristics**

This precision-engineered lift boasts a rational design with hydraulic power for smooth operation, low noise levels, and user-friendly controls. Featuring dual hydraulic cylinders for stable lifting, it employs synchronized wire ropes to ensure both pulley move in unison, effectively preventing vehicle tilting. A single manual safety mechanism guarantees reliable protection. The extended toothed block in the boom locking mechanism prevents accidental detachment, making vehicle lifting safer than ever.

## **3 Main technical parameters**

**\* Note: Different voltage and frequency products can be provided according to user requirements (see equipment label for specific parameters)**

model	LTPF9
Maximum lifting weight (LBS)	9000
Lift height (mm)	1800
Full lift time (s)	60
Voltage	110V/220V/380V
Power of motor	2.2KW
Rated oil pressure	20MPa
Working temperature	-5°C~+40°C
Transportation/storing temperature	-5°C~+40°C
Use altitude	≤2000 meters

## **4. Lifting machine dimensions**

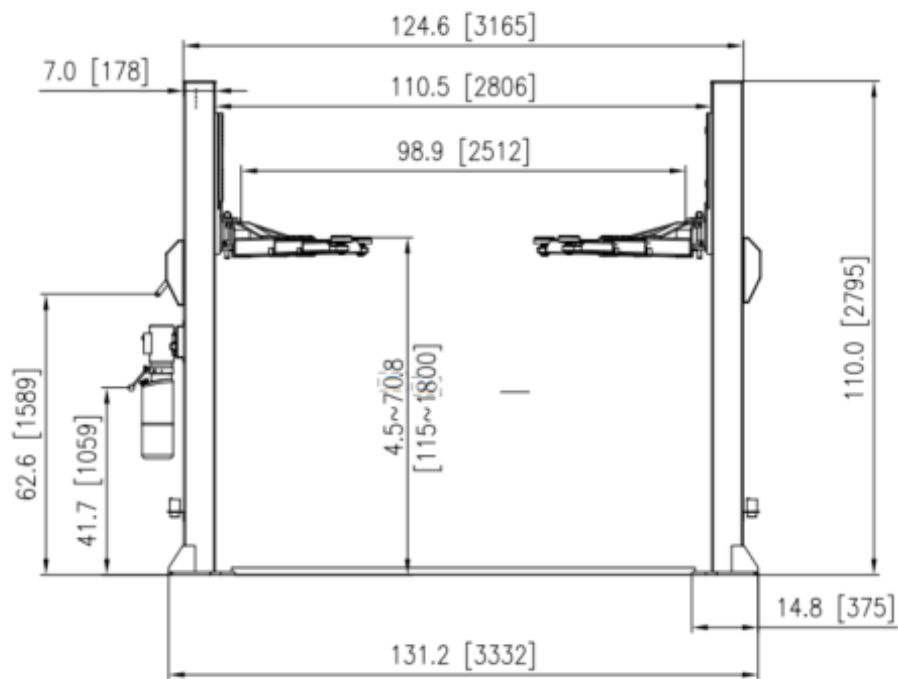

Figure 1 Lifting machine dimensions

## 5. Lifting machine foundation dimensions

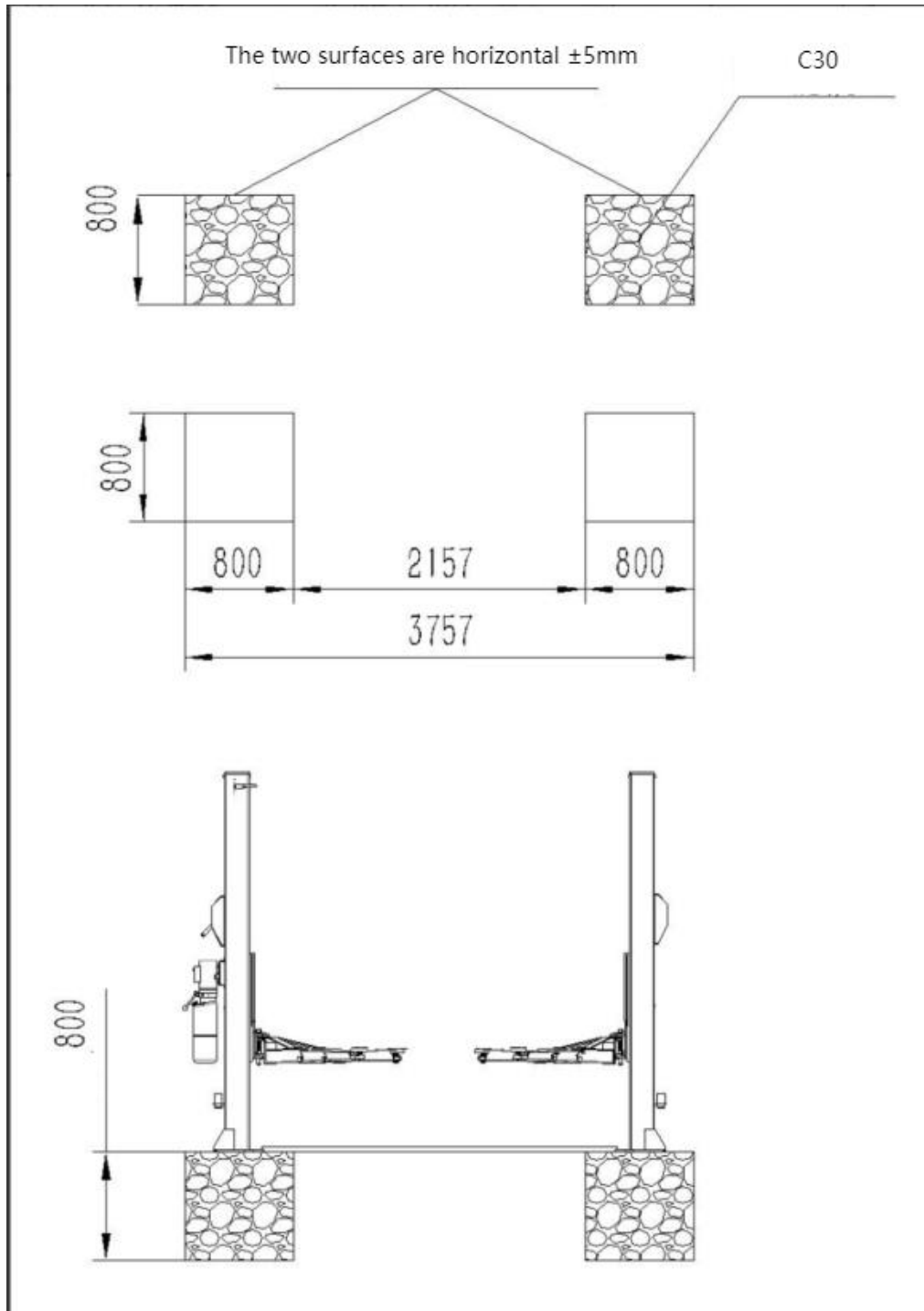
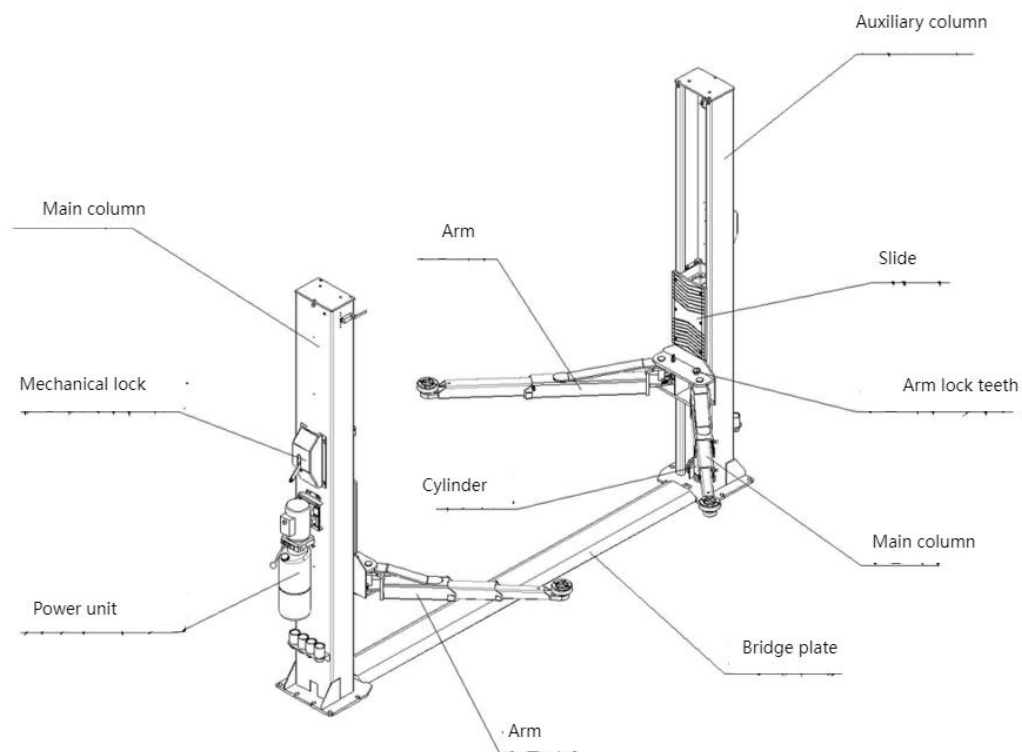

Figure 2 Lifting machine foundation size diagram

## 6. Lifting machine structure and working principle

The lift is composed of main column, auxiliary column, bridge plate, pulley, support arm, cylinder, power unit, mechanical safety, chain and so on (see Figure 3).



**Figure 3 Lifting machine main structure**

- Pillar: the basic part, used to install the trolley, cylinder and other driving devices.
- Sliding car: lifting part, installed in the column, up and down sliding.
- Arm: lifting part, installed with the pulley, in contact with the car support point, lifting the car.
- Bridge plate: a bridge component placed at the bottom to balance steel wire rope, oil pipe, safety rope and so on through the bridge plate from the main column to the auxiliary column.
- Safety unlocking mechanism: safety parts, oil pressure discharge, lock teeth top lifting pulley lock block, pulley stationary.
- Cylinder: Transmission part, hydraulic station works, high pressure oil is injected into the cylinder, the piston rod rises, and the chain drives the car up.
- Power unit: power part, motor operation, drive the pump to work, through the filter screen to suck oil, push out high pressure oil.
- Lock arm device: safety part that locks the support arm so that it cannot turn.
- Chain: transmission part, one end is fixed on the column base plate, one end is fixed on the carriage, when the hydraulic station works, the high pressure oil is injected into the cylinder, the piston rod rises, the chain rises, the chain then drives the carriage up.

operational principle :

- When rising, the motor on the hydraulic station drives the oil pump to input the hydraulic oil into the cylinder. Under the action of oil pressure, the piston rod of the

cylinder is pushed out to the market, and the chain drives the pulley and support arm to rise synchronously, completing the lifting work.

- When descending, open the hydraulic station return oil pipeline. Under the weight of the pulley, the hydraulic oil in the cylinder is discharged back to the oil tank to complete the descent work.

## **7. Lifting machine installation and debugging**

### **Installation precautions:**

- **Wrong installation may cause damage to the lift or personal injury. The manufacturer shall not be liable for any damage, whether direct or indirect, caused by incorrect installation or improper use of this product.**
- **The correct installation location should be a "level" surface that ensures proper leveling. Slight ground inclinations can be compensated for with appropriate thin shims. Any significant tilting will compromise the device's leveling performance. If there is suspected tilting, visual inspection should be conducted or a new level concrete floor should be poured where possible. In short, the leveling degree of equipment during optimal leveling depends on the ground's inherent levelness – do not expect it to compensate for severe tilting.**
- **This device must not be installed on any asphalt surface. According to the minimum specifications in the general ground requirements, it should not be installed on any surface other than concrete. Installation is prohibited on large cracks, fissures, or defective concrete surfaces. Consult your construction engineer for inspection.**
- **The device shall not be installed on the second floor with a basement without the written approval of the architectural engineer.**
- **Head obstruction: there should be no head obstruction in the area where the lift is installed, such as heaters, building supports, electrical pipelines, etc.**
- **Ground borehole test: The thickness of concrete in each site can be determined by the ground borehole test. If multiple lifts are installed at one site, it is advisable to perform borehole tests at each installation location.**
- **Power supply: The power supply should be ready before installation. It is recommended that all electrical wiring be done by a certified electrician.**

Before installing the machine, read the instruction carefully to understand the structure of the machine, check whether the machine is damaged in transportation and loading, whether the accessories are complete, and then follow the following steps:

7.1 The equipment shall be installed in a dust-free and contamination-free indoor environment with adequate lighting (with illuminance no less than 100 Lx). The lift column must be installed at specific safety distances from walls, columns, and other equipment, maintaining a minimum clearance of 1000mm from the wall surface. Sufficient space should be reserved both front and rear of the lift to accommodate all vehicles (see Figure 4). Emergency access routes shall be provided with adequate

clearance for safety purposes and operational convenience, while the indoor ceiling height must not be less than 4000mm.

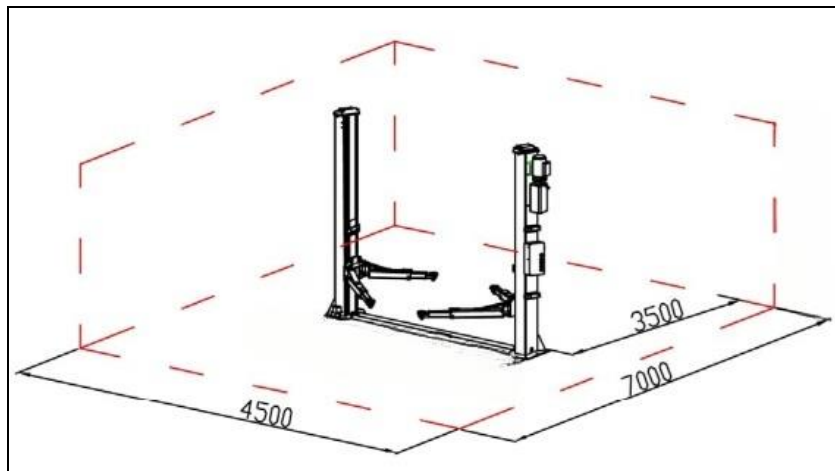

Figure 4

7.2 The lift can only be installed on the concrete ground, the foundation concrete is C30 grade, the thickness is more than 800mm, the horizontal error is less than 5mm, and the newly cast concrete needs to be dry for more than 20 days (see Figure 2).

7.3 Place the main column on the foundation, drill a hole with an impact drill, clean the residual dust in the bolt hole with a vacuum cleaner, and tap the expansion bolt into the hole with a hammer. The height of the expansion bolt exposed above ground should not be greater than 50mm, and the nut should not be tightened. (Figure 5)

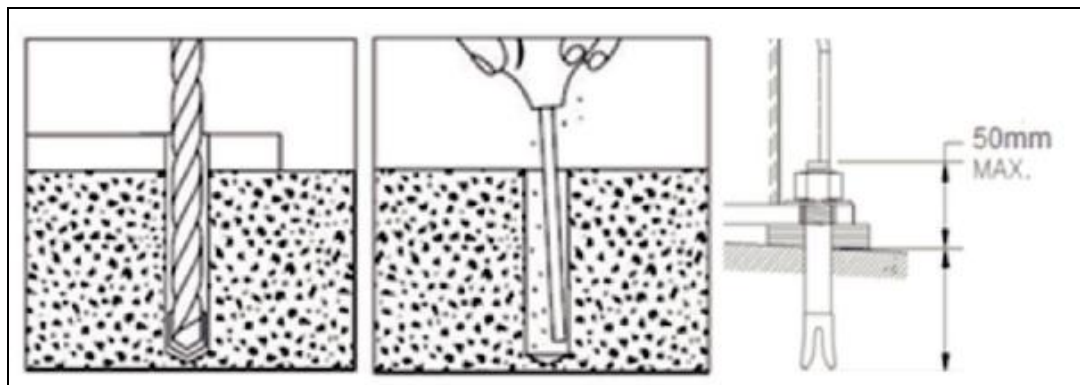

Figure 5

**Drilling points:**

1. **Do not use a drill that is excessively worn or damaged.**
2. **Keep the drill perpendicular to the ground during drilling.**
3. **Do not use too much force when drilling. Occasionally, the drill bit should be removed to clean up the debris in the hole.**
4. **The depth of the borehole shall be equal to the length of the expansion bolt, and the distance between the bolt head and the concrete floor shall not be less than twice the diameter of the bolt. If the borehole fails, the lift shall be moved to another position for reinstallation.**

7.4 Fix the auxiliary column according to the method of the main column. According to

the size on Figure 1, confirm that the diagonal distance between the base plates of the two columns is less than 3mm.

7.5 Tighten the expansion bolt and check the verticality of the column with a level. If necessary, insert a shim at the bottom of the column to adjust the level. (See Figure 6)

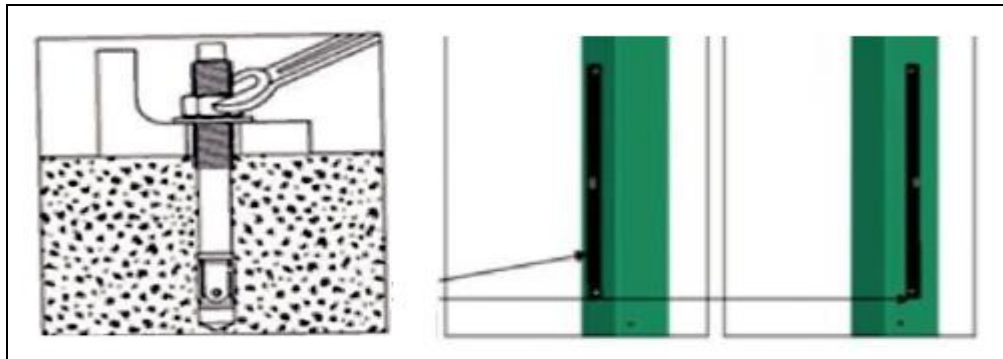

Figure 6

**Note: 1. Tighten the foundation bolts only with a torque wrench. Do not use an impact tool to tighten them.**

**2. The thickness of the shim added at the same position under the base plate should not exceed 5mm. The perimeter of the column base plate should be firmly padded, otherwise the support arm will shake when lifting the vehicle.**

7.6 Install the balance wire rope to ensure both side carriages are engaged at the first safety stop. Position the balance wire rope along the trajectory shown in Figure 7. Do not tighten the nuts initially; adjust the tension of both wire ropes during synchronization testing.

**Note: The screw on one wire rope must be fully tightened. When making adjustments, ensure both carriages remain locked at the same height.**

**The two steel ropes are required to be adjusted to a certain tension and consistency to ensure that the pulleys on both sides move synchronously.**

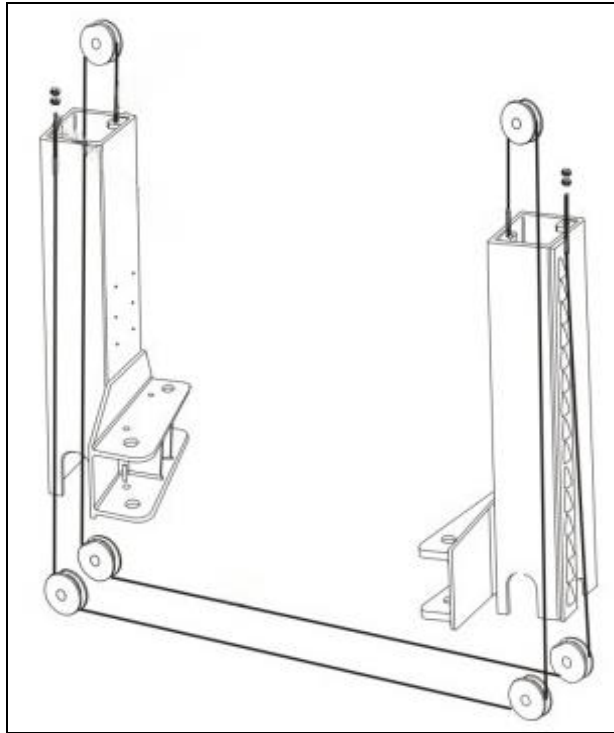

**Figure 7 Wire rope pulley set**

**7.7 Install the safety release rope**

Installation of the insurance unlocking rope as shown in Figure 8:

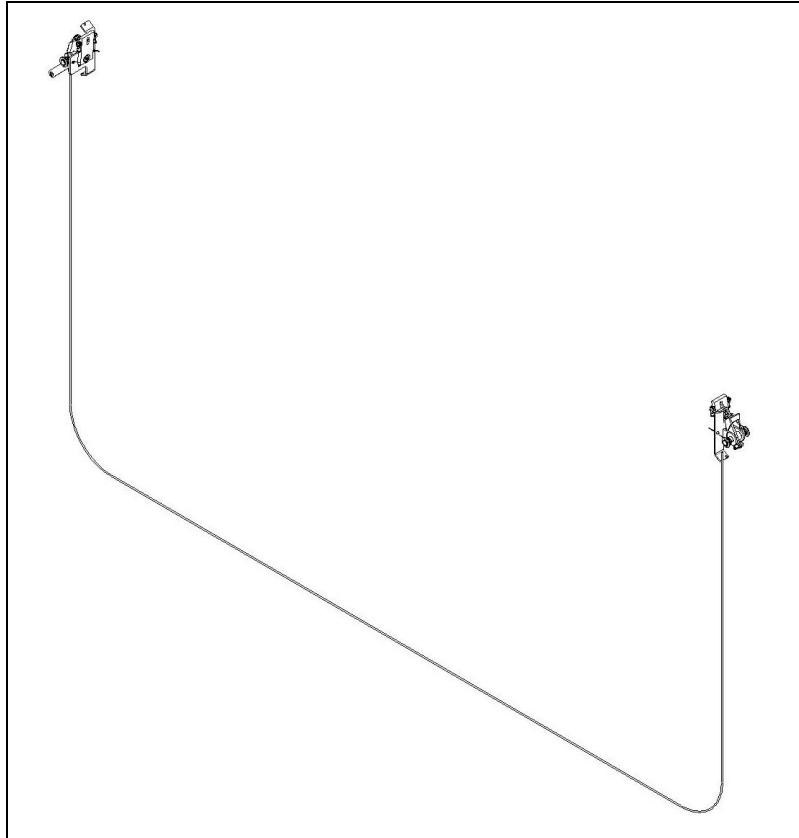

**Figure 8. Insurance unlocking rope connection diagram**

pay attention to :

- The safety unlocking rope is required to be adjusted to the safety opening and closing on the main and auxiliary columns.
- Ensure the safety and reliability of the insurance during normal use. If the insurance cannot be reset, stop the machine immediately, do not lift the operation, and can be used only after the problem is eliminated.
- Except for the two fixed ends and pulley, the insurance unlocking rope shall not contact any stationary or moving parts of the column.

**7.8 Support Arm Installation:** Secure four support arms into the carriage using pins, with short arms at the front and long arms at the rear. (Note: Use short arms for the front end, and ensure each arm shaft is properly fitted with retaining springs. Before installation, verify that the positioning gear mechanism at the end of each arm aligns properly. Adjust the bolts securing the semi-gear to achieve proper alignment. Lubricate both the support arms and carriage components during installation to ensure smooth movement.)

When the distance between the small tooth and the large tooth is adjusted, tighten the fixing screw of the large tooth. As shown in Figure 9.

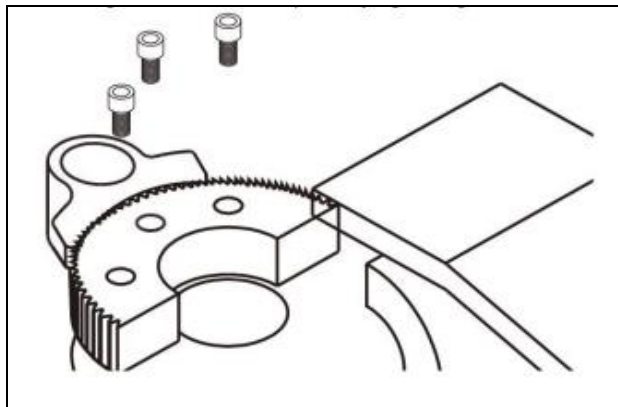

Figure 9

**Note:** The support arm can only be installed after the column is fixed with the expansion bolt.

7.9 Mount the power unit on the main column motor plate and secure it with bolts and nuts. Connect the power cables according to the electrical schematic diagram of the hydraulic system shown in Figure 12. During initial installation, use a lift machine. When wiring, ensure the motor rotates clockwise. Incorrect rotation direction may cause gear pump wear if prolonged. Power cable requirements for installation: Three-phase power core wires must be at least 2.5mm<sup>2</sup>, and single-phase power core wires must be at least 4.0mm<sup>2</sup>.

7.10 Hydraulic system connection:

Loosen the fuel tank cap and add 10L of 46# anti-wear hydraulic oil. The oil level should be positioned approximately 10mm above the top of the tank at its highest point,

and 30mm below the bottom (measure using a dipstick on the tank's air vent when the lift is lowered). Handle with care during refilling to prevent dust or contaminants from mixing into the oil. (Priority: 46# anti-wear hydraulic oil; if temperature drops below 10°C, consider 32# hydraulic oil). Important note: **Never mix different brands or models of hydraulic oil.**

Connect the oil pipe according to the hydraulic system connection diagram shown in Figure 10. Adjust the "overflow valve" to change the system pressure (it has been adjusted at the factory) and the lifting capacity (but not over the rated oil pressure). Press down the handle of the manual unloading valve to achieve the downward action.

**pay attention to :**

- **Protect the pipeline joint during oil pipe process, and strictly prevent sand from entering the oil circuit.**
- **If the hose is to pass through the column during installation, ensure that the pipeline does not touch any moving parts.**
- **After the lifting oil pipe is connected, the oil pipe inside the column should be straightened and fixed on the inside of the column to avoid friction between the carriage, wire rope and pulley and the oil pipe.**
- **In the hydraulic system, air may be installed and exhaust treatment is required. When connecting the pipe, the hydraulic cylinder should be in the lowest position, and then the air chamber is minimized. Then the hydraulic cylinder should be raised and lowered several times during the no-load test.**

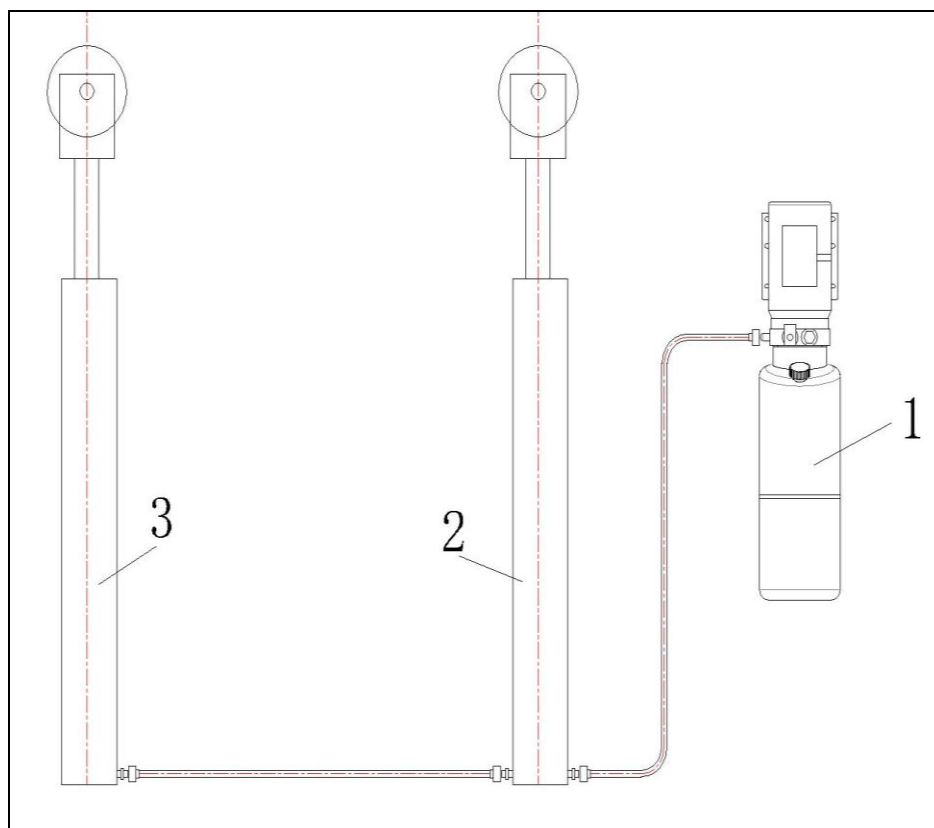

Figure 10 Lifting machine hydraulic system connection diagram

Hoist hydraulic system connector list		
Number	Item	Quantity
1	power unit	1
2	Main column cylinder	1
3	Sub-column cylinder	1

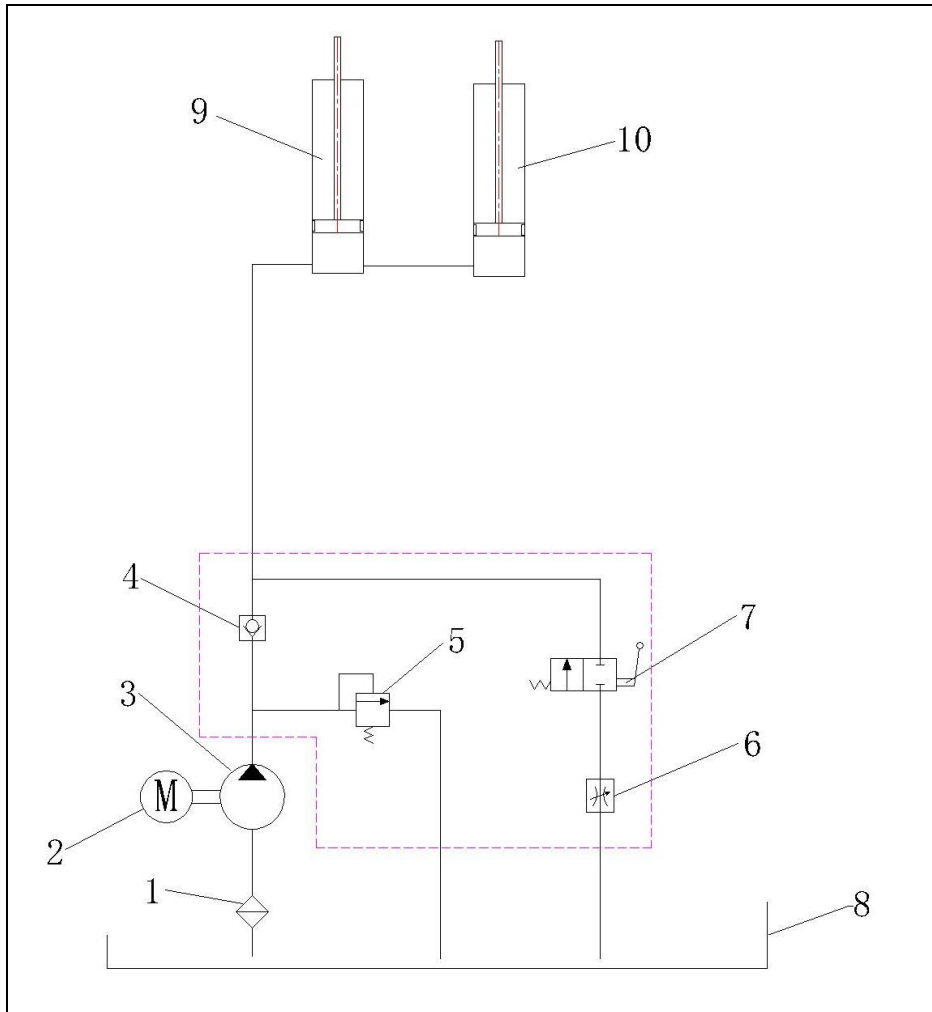

Figure 11 Hydraulic system schematic

order number	name	quantity
1	Oil filter	1
2	Gear pump	1
3	Motor	1
4	Check valve	1
5	Overflow valve	1
6	throttle valve	1
7	Manual unloading valve	1
8	Fuel tank	1
9	Main column cylinder	1

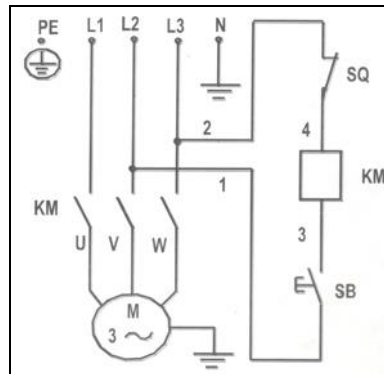

Figure 12 Electrical schematic

**Important: External power cables must be directly connected to the air switch, never through a socket. Remove the cover from the electrical box on the hydraulic station and connect wires according to the circuit diagram. Note: The lift should be equipped with a power switch for maintenance and emergency power cutoff. Ensure the oil tank is fully filled before operating the hydraulic station. Test by pressing the upward button. If the motor fails to operate or abnormal noises and overheating occur, immediately shut down and verify electrical connections.**

#### 7.11 Adjustable plate chains

Install the adjustment plate chain to the correct position (see Figure 13), specifically at the lowest point where the support arm can swing freely without scratching the floor. This step is pre-adjusted by default, but customers may make fine-tuning adjustments post-installation (after completing electrical and hydraulic system installation). To adjust: First lift the carriage to a high position, lock it and lower for 2 seconds. Set the adjustment nut to the desired position, then raise the carriage. After locking and releasing, proceed with required operations.

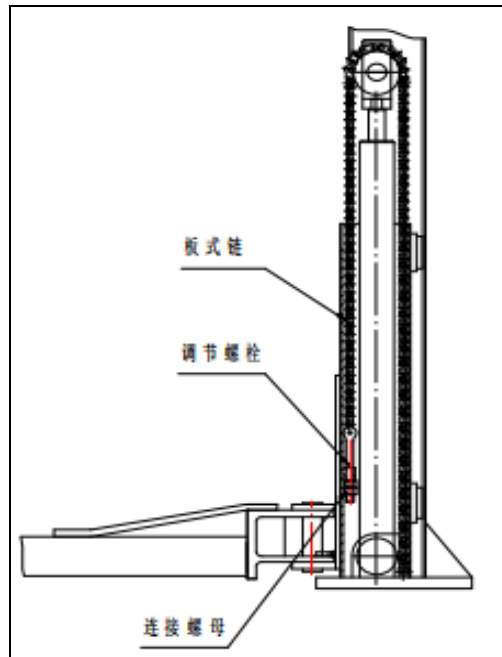

Figure 13

7.12 Install the bridge plate at the bottom according to the position shown in Figure 1, cover the oil pipe and steel wire rope from the main column to the auxiliary column, and install accessories such as column cloth curtain, carriage anti-collision strips, arm guardrails and other accessories..

#### 7.13 No-load test adjustment

- Clean the site, the ground should not be oily, the lift is empty, and the general lithium base grease should be added to the moving contact surface of the carriage. It is required that all sliding surfaces from top to bottom are evenly coated.
- Connect the power supply, press the up button, the trolley rises, stop rising at any position, press the return oil handle on the hydraulic station, and put the left and right trolley into the same safety gear.
- Tighten the balance wire rope nut to make the two balance wire ropes have basically the same tightness.
- Press the up button to lift the carriage a distance, disengage the safety, pull the safety handle on one side and press the return handle on the hydraulic station on the other side to lower the carriage to the lowest position.
- Press the upward button to lift the whole process. When the limit position is reached, the motor stops running, the relief valve opens, the hydraulic system returns oil, and the carriage stops rising. Observe the synchronization of the left and right carriage support arms during the lifting process. If there is obvious difference, continue to adjust the balance wire rope nut to loosen and tighten to achieve synchronization of the left and right carriage.
- In the hydraulic system, air may be present due to new installation and exhaust treatment is required. The rise and fall can be repeated several times during no-load

test.

#### 7.14 Load test adjustment

- Lower the carriage to the lowest position, and retract the four support arms to the minimum length and fully open them to ensure that there is no obstacle in the lane space.
- Drive the car into the lift, center left and right, with the column line as the reference, the front and rear distance ratio of the vehicle is roughly 2:3 (front engine vehicles), when the tonnage of the vehicle is more than 3.5 tons, move the vehicle appropriately to the rear.
- Rotate the support arm tray to the chassis support point.
- Press the up button to raise the arm, and confirm that all four arm locks are fully locked.
- Continue to click up and observe if any of the rubber trays touch the bottom support point, stop rising, and then adjust the remaining rubber trays so that they all contact the support point.
- Press the up button slowly to lift the car. Stop lifting when the tires are off the ground. Gently push the rear of the car to check the contact condition and ensure that the car is safe and stable and the support arm lock is fully locked.
- Press the upward button to continue raising the vehicle. Observe whether the lifting process remains stable in all directions. When the trolley reaches the third or fourth safety gear, stop the ascent. Press the return lever on the hydraulic station to release the oil, locking the trolley. Check if all sides remain level. (If significant height difference is observed between left and right sides, adjust the balance wire rope nuts).
- Continue to rise to the highest tier of insurance, stop rising, press the return oil handle on the hydraulic station, and lock the return oil. Observe whether the lift is stable without vibration.
- When the point moves up, the carriage is released from the safety. Hold the safety handle on one side and press the return handle on the hydraulic station on the other side to lower the carriage.
- At any middle position, release the safety handle, the safety will automatically rebound, the carriage is locked, and the descent is stopped.
- When the lifting point moves upward and the carriage disengages the safety device, grip the safety handle on one side while pressing the return handle on the hydraulic station with the other hand. At any position in the middle, release the safety handle. The safety device will automatically rebound, locking the carriage and stopping the descent. Repeat this action at least three times to confirm that the mechanical safety device is safe and reliable.
- During the lifting of the car, observe whether there is any abnormal sound and whether there is friction interference between the steel wire rope and other parts.
- After running several cycles up and down, it may be necessary to refill the oil into the tank. After refilling, the oil level is about 10mm above the top of the tank at the highest and 30mm above the top of the tank at the lowest (check with the probe on

the oil filling air cover on the top of the tank).

## **8. Lifting machine operation instructions**

### **8.1 Operating Precautions**

8.1.1 The center of gravity of each car is different. First, understand the center of gravity of the car. When the car enters the lift, make sure that the center of gravity is close to the plane formed by the two columns. Ensure that the lifting position is at the recommended lift point of the vehicle manufacturer.

8.1.2 When lifting the vehicle, pay attention to observe the position of the roof and do not get close to the crossbeam or other head obstacles to avoid accidents.

8.1.3 The hydraulic valve shall be adjusted well before leaving the factory. The user shall not adjust it by himself, otherwise the user shall be responsible for all consequences arising therefrom.

8.1.4 Some parameters in the specification can be changed according to actual needs.

8.1.5 Do not operate a lift with broken ropes or damaged or dropped parts.

8.1.6 Before use, it is necessary to check whether the locking mechanism at the end of the support arm is consistent, whether there is a broken wire rope, and whether the rubber pad is deformed.

8.1.7 All support arms must be used when lifting the vehicle.

8.1.8 Before lifting the vehicle, check all pipe joints and ports for oil leaks. If there is a leak, do not use the lift.

8.1.9 After the vehicle is lifted, a jack should be used to support and maintain the balance of the vehicle when adding or removing any major weight.

8.1.10 When the lift is not working, the power must be cut off.

8.1.11 This lift is designed for lifting the entire vehicle body and shall not be used for other purposes.

8.1.12 Check the upper and lower areas of the vehicle. There should be no obstacles in this area before the lift runs.

8.1.13 Lift the vehicle once with empty load for the whole trip to ensure that the lifting machine is in good condition before carrying out load operation.

8.1.14 During the operation of the lift, the operator shall keep his eyes on the load device.

8.1.15 The mechanical safety device shall be locked before entering the area below the lifted vehicle.

8.1.16 When the vehicle is on the lift, avoid excessive shaking of the vehicle.

8.1.17 Climbing on a lifted vehicle or load is prohibited.

8.1.18 Only authorized personnel may enter the lifting area.

8.1.19 During the operation of the lift, no one is allowed to stand in the lifting area.

8.1.20 It is prohibited to attempt to lift a vehicle that is too wide or too long.

8.1.21 It is prohibited to dismantle, interfere with or modify the safety device of the lift.

**The above precautions should not cover all possible situations and conditions.**

**Operators need to have sufficient safety awareness.**

## **8.2 Operating steps**

**To prevent injuries and financial losses, only trained personnel are permitted to operate the lift. After familiarizing yourself with the operating instructions, practice lifting several cycles to master the control system. The vehicle must be supported by all four lifting pads; lifting only one end or corner is strictly prohibited. The vehicle can only be lifted after the lift has been securely fastened and stabilized.**

### **8.2.1 Vehicle positioning**

- Guide the vehicle to enter the work station slowly.
- Stop the vehicle at the center of the lift and tighten the handbrake.
- Place a wheel stop to fix the rear wheel.

### **8.2.2 Adjust the support arm**

- Select suitable rubber pad [optional].
- Adjust the lift arm to the specified lifting point of the vehicle [Refer to the vehicle maintenance manual].

### **8.2.3 Test lift**

- Press the up button to lift the vehicle 10-15cm off the ground.
- Shake the vehicle vigorously to confirm stability.
- Check whether the contact point of the support arm is firm.

### **8.2.4 Full lift**

- Continue to lift up to the working height.
- Confirm that the safety lock is in the toothed state.
- Place a "working" warning sign.

### **8.2.5 Downward operation**

- Clear tools and debris under the equipment.

- Press the up button to lift the vehicle and then manually release the safety lock.
- Press the hydraulic station return oil handle, and the carriage is slowly lowered until the support arm is completely unloaded.
- Return the support arm to the parking position.

### **Emergency handling:**

- 1. In case of power failure/fault, manually unlock and slowly descend using the manual pressure relief valve.**
- 2. Stop operation immediately if abnormal sound is found.**
- 3. When the hydraulic oil leaks, cut off the power supply and report for repair.**

## **9. Lifting machine maintenance and upkeep**

### **9.1 Keep clean**

- **This machine should be cleaned with a dry cloth to keep it clean. Before cleaning, the power should be cut off to ensure safety.**
- **The working environment of this machine should be cleaned frequently and kept clean. If there is more dust in the working environment, it will accelerate the wear and tear of the parts and shorten the service life of this machine.**

### **9.2 Daily inspection items**

- 1) Check all hydraulic joints, oil pipes and cylinders for leakage and wear.
- 2) Check all electrical connections for damage.
- 3) Check all moving parts for excessive wear and replace them immediately if any wear is found.
- 4) Clean the oil on the rubber tray and observe whether there is excessive wear on the rubber tray.
- 5) Check whether the safety insurance agency is normal.
- 6) Check whether the wire rope connection is normal and whether the tension is appropriate.
- 7) Check whether the connecting nut of the plate chain and carriage is loose or fallen off. (See Figure 13)
- 8) Check whether the bracket lock is locked in place.

### **9.3 Monthly inspection items**

- 1) Change the grease in the column slide, and add the grease at the pulley and gear.
- 2) Check and lock the expansion bolt nut.
- 3) Lubrication chain, wire rope.
- 4) Check all hydraulic lines for wear and replace them immediately if any wear is found.

- 5) Retighten the anchor bolts. (Note: All anchor bolts should be fully tightened. If any bolt is not working, turn off the lift until the bolt is replaced.)

#### 9.4 Items to be checked every 6 months

- 1) Adjust the balance wire rope and safety rope to ensure synchronous horizontal lifting.
- 2) Check for possible wear, interference or damage to all moving parts.
- 3) Check the verticality of the column.
- 4) Check the lubrication of all pulleys. If the pulley is dragged during lifting, add appropriate lubricating oil to the wheel shaft.

#### 9.5 Hydraulic system maintenance

After 6 months of the first use of this machine, the hydraulic oil tank should be cleaned and the hydraulic oil should be replaced. After that, the hydraulic system should be cleaned and the hydraulic oil should be replaced every year. If the hydraulic oil is black or there are dirt in the tank, the hydraulic oil should be replaced immediately. When changing the oil, the oil tank and filter should be cleaned.

9.6 The operator should often check the visible parts and fixed parts of the wire rope. If any of the following conditions occurs, the wire rope should be scrapped and replaced with a new one in time (see Figure 14).

9.6.1 Breakage of the whole rope strand.

9.6.2 When there are more than 9 broken wires in the length of 80mm or more than 20 broken wires in the length of 350mm.

9.6.3 When the outer diameter reduction due to wear exceeds 15%.

9.6.4 Wire breakage aggregation when the same strand or concentrated in a very short range.

9.6.5 Severe corrosion of steel wire rope.

9.6.6 Twisting of steel wire rope.

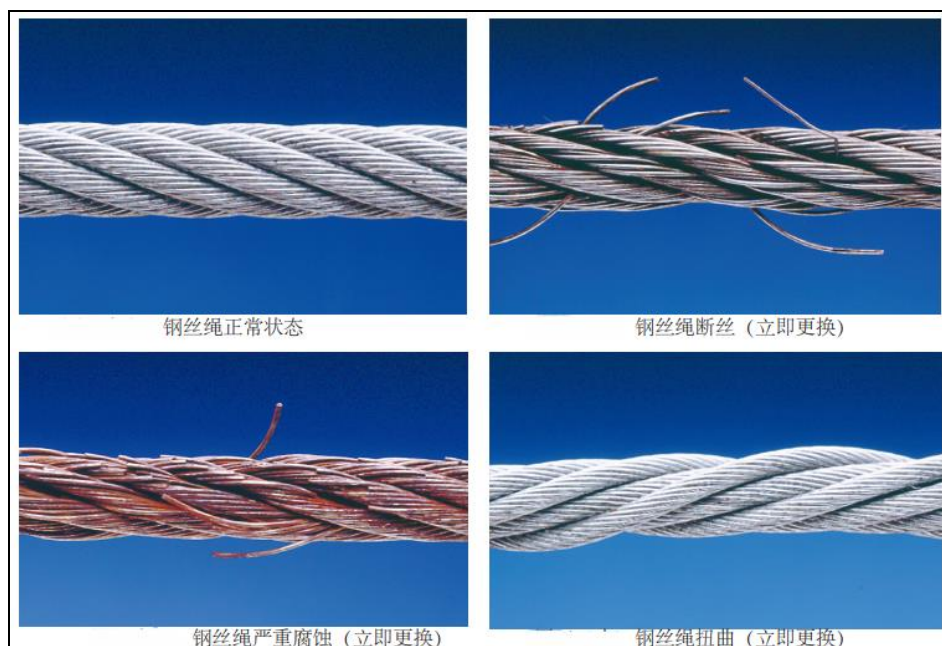

**Figure 14**

**Noise statement**

**The lifting machine operates at a noise level of less than 80dB (A).**

**11. Lifting machine breakdown diagram and details**

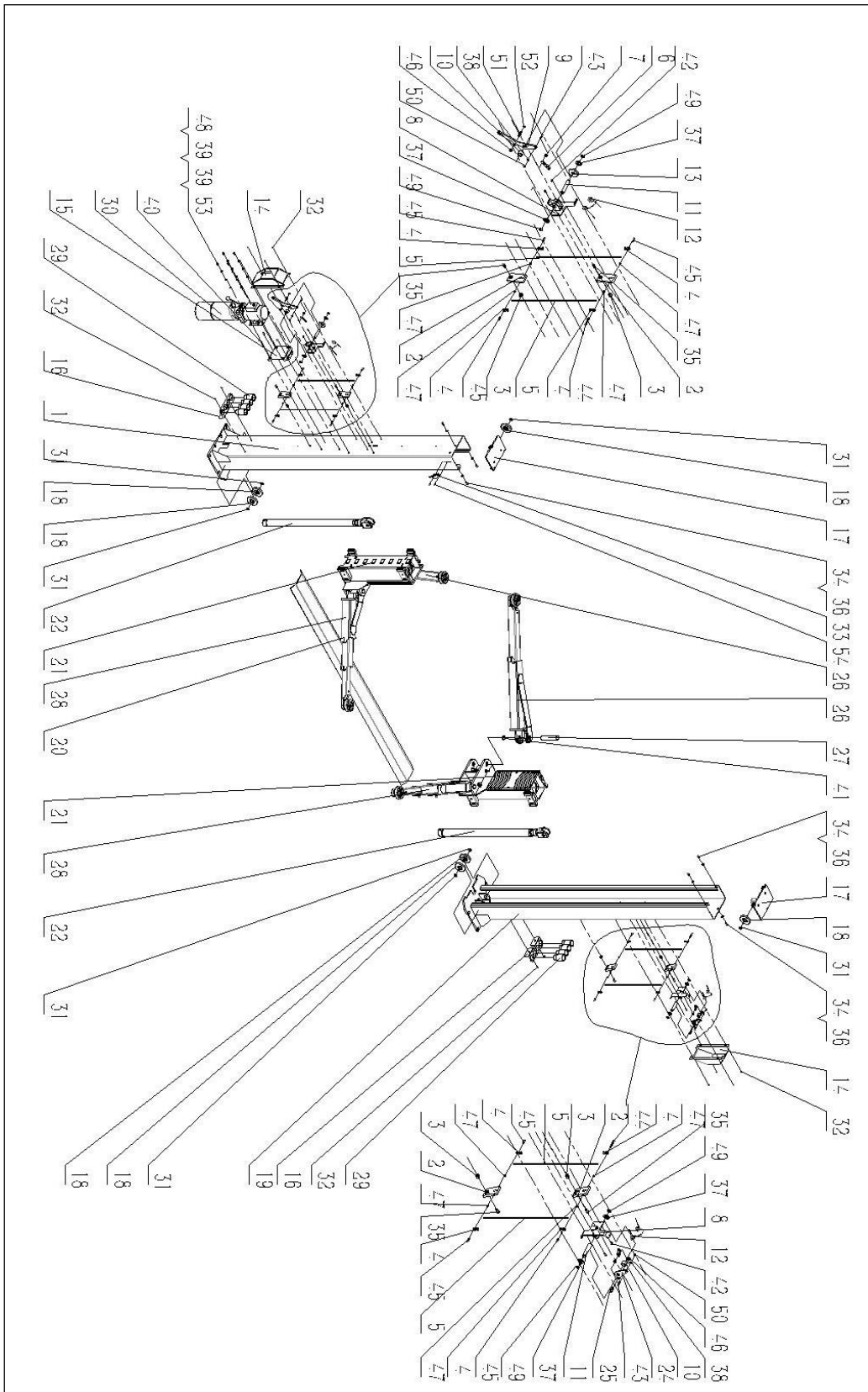





















































Figure 15 LTPF9 lifting machine disassembly diagram

**LTPF9 lift machine complete disassembly details list**

<b>Number</b>	<b>Preview</b>	<b>Item</b>	<b>Quantity</b>
1		Assembly of main pillars	1
2		Pillar lock plates	4
3		Pillar lock plate fixing nut	4
4		Φ 6/M6 joint bearing	8
5		Lock bar[660]	4
6		Main column lock pull plate	1
7		Pillar lock pull plate spacer	2
8		Joints and lock frame welding	2
9		Unlock the column plate	1
10		Unlock the column pressure plate spacer	2
11		Unlock the column release plate shaft	2
12		Unlock the spring of the column	2
13		Main column lock wire guide wheel	1

14		Pillar lock cover	2
15		Pump station installation frame	1
16		Increased stent height	2
17		Column cover plate assembly welding	2
18		Rope sheave	6
19		Sub-column welding	1
20		Bridge plate assembly welding in the middle of column	1
21		Carriage	2
22		Hydro-cylinder	2
23		Sub-column lock pull plate	1
24		Sub-column unlocking plate	1
25		Column unlocking shaft	1
26		Long arm	2

27		Arm shaft	4
28		Short arm	2
29		Toe High Stocking [70]	8
30		Power unit	1
31		Axial elastic retaining ring A type 25	6
32		Cross groove head screw M6x8	12
33		ME-8108 limit switch	1
34		Hexagonal cylindrical head screw M10x16	6
35		Hexagonal cylindrical head screw M10x20	4
36		Gasket A Class 10	6
37		Gasket A Class 20	4
38		Gasket A Class 6	2
39		Gasket A Class 8	8
40		Hex head flange face bolt with teeth M8x10	4

41		Axial elastic retaining ring A type 38	4
42		Hexagonal cylindrical head screw M6X10	4
43		Hexagonal cylindrical head screw M6X30	2
44		Hexagonal cylindrical head screw M6X55	2
45		Hexagonal cylindrical head screw M6X20	6
46		Hex nut Grade A M10	2
47		Hex nut Grade A M6	8
48		Hex nut Grade A M8	4
49		Axial elastic retaining ring A type 20	4
50		Type 1 non-metallic insert hexagonal locking nut M6	2
51		Column unlocking shaft	1
52		Axial elastic retaining ring A type 10	1
53		Hex head bolt full thread M8x20	4
54		Hexagonal cylindrical head screw M5X10	2

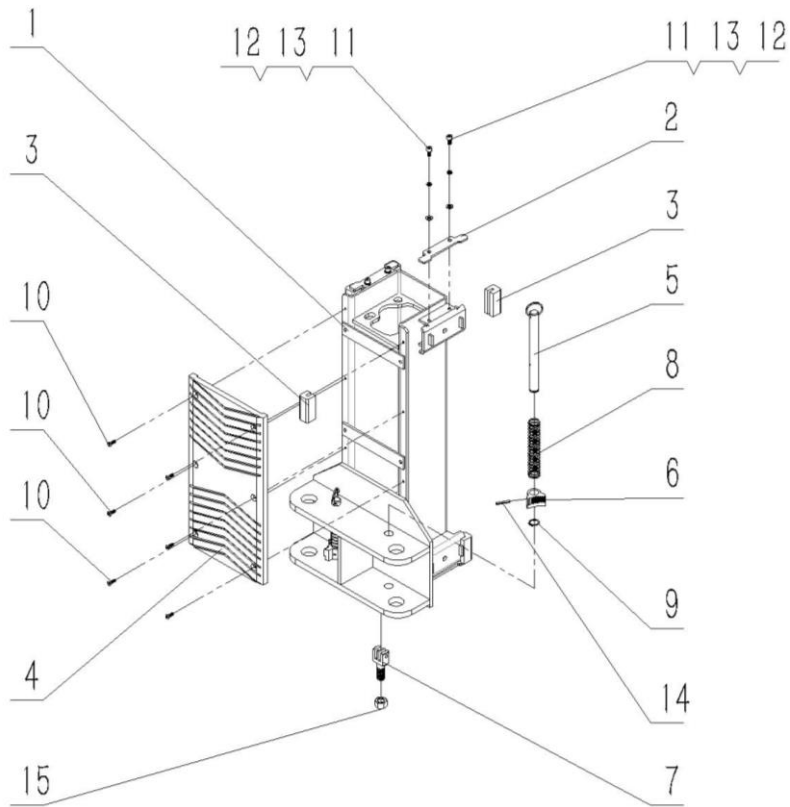

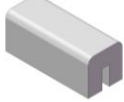











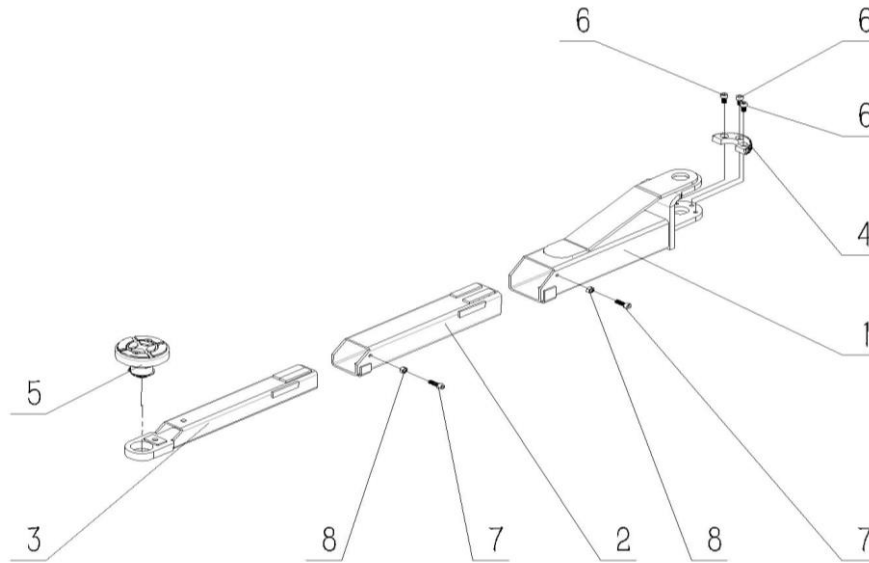



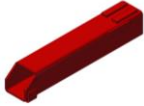





Figure 16 LTPF9 lift pulley breakdown

LTPF9 lift pulley breakdown list			
Number	Preview	Item	Quantity
1		Carriage welding assembly	1
2		Carriage pressure plate	4
3		Slider	8
4		Slipper anti-collision rubber plate	1
5		Assembly of slide release shaft	2
6		Carriage pinion	2

7		Carriage chain bolts	1
8		Release shaft spring of the carriage	2
9		Axial elastic retaining ring A type 22	2
10		Cross groove countersunk screw M6×20	6
11		Hexagonal cylindrical head screw M8×16	8
12		Gasket A Class 8	8
13		Elastic gasket 8	8
14		Elastic cylindrical pin 5×35	2
15		Hex nut Grade A M18	1



**Figure 17 LTPF9 lift short support arm breakdown**

<b>LTPF9 lift short support arm breakdown details</b>			
<b>Number</b>	<b>Preview</b>	<b>Item</b>	<b>Quantity</b>
1		First short support arm welding	1
2		Second short support arm welding	1
3		Third short arm support arm welding	1
4		Arm lock teeth	1
5		Pallet	1
6		Hexagonal cylindrical head screw M10×20	3
7		Hexagonal cylindrical head screw M10×30	2
8		Hex nut Grade A M10	2

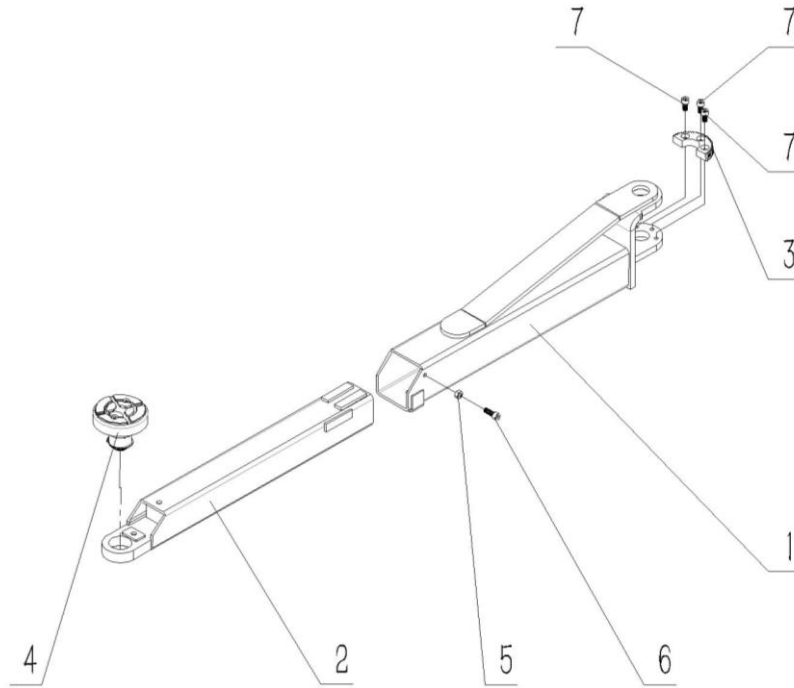









Figure 18 LTPF9 lift long support arm breakdown

LTPF9 lift long support arm breakdown schedule			
Number	Preview	Item	Quantity
1		First short support arm welding	1
2		Second short support arm welding	1
3		Arm lock teeth	1
4		pallet	1
5		Hex nut Grade A M10	1
6		Hexagonal cylindrical head screw M10×30	1
7		Hexagonal cylindrical head screw M10×20	3

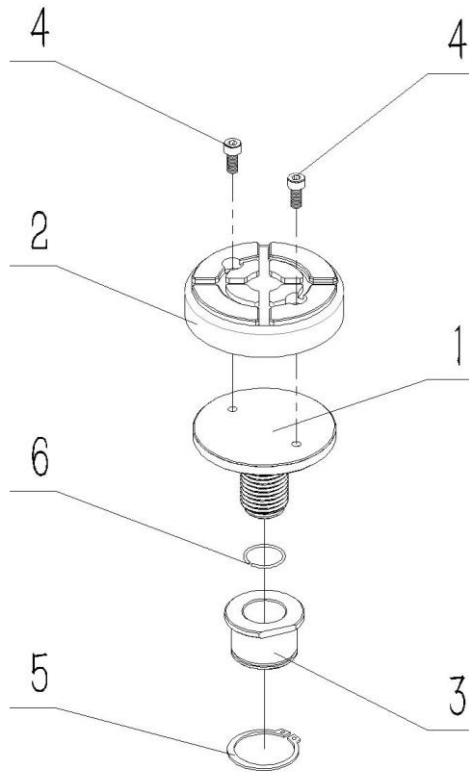







Figure 19 LTPF9 lift pallet component breakdown

LTPF9 lift pallet component breakdown list			
Number	Preview	Item	Quantity
1		Pallet	1
2		Pallet pads	1
3		Pile spiral	1
4		Hexagonal cylindrical head screw M8×20	2
5		Shaft elastic retaining ring A type 50	1
6		Shaft steel wire retaining ring 30	1

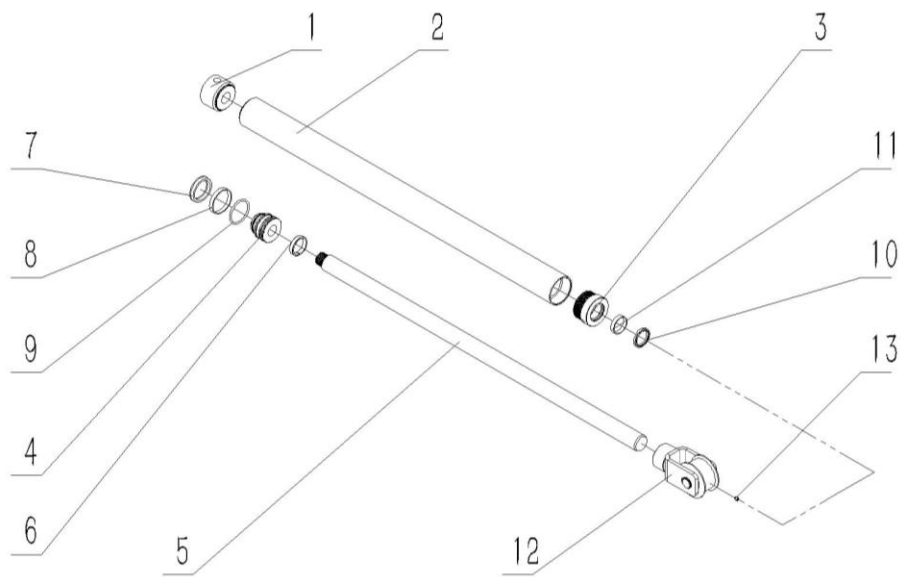









Figure 20 LTPF9 lift oil cylinder disassembly diagram

LTPF9 lift oil cylinder breakdown details			
Number	Preview	Item	Quantity
1		Cylinder base	1
2		Oil cylinder	1
3		Guide bushing	1
4		Plunger	1
5		Piston rod	1
6		Cylinder liner	1
7		Seal ring UN63-48-10	1

8		Guide ring 63-58-9.5	1
9		O-ring D63X4	1
10		Dust seal DH48-40-5-6	1
11		Guide ring 44-40-9.5	1
12		Chain wheel frame assembly	1
13		Internal hexagonal cone end fastening screw M8×10	1

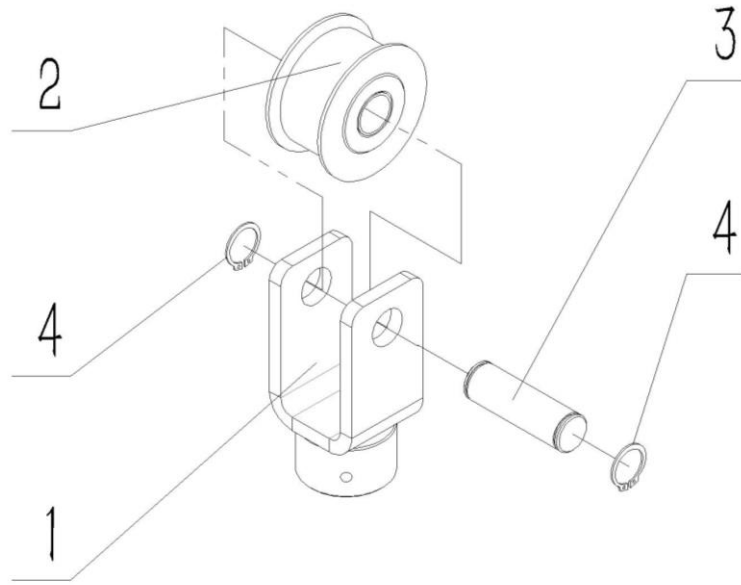





Figure 21 LTPF9 lift chain wheel frame disassembly

LTPF9 lift chain wheel frame breakdown details			
Number	Preview	Item	Quantity
1		Chain rafter assembly welding	1
2		Chain wheel	1
3		Chain wheel bracket shaft	1
4		Shaft elastic retaining ring A type 25	2

## 12. Faults and troubleshooting

Fault phenomenon	Causes	Method of exclusion
The motor does not turn up	<ol style="list-style-type: none"> <li>1. The button switch circuit is broken</li> <li>2. AC contactor coil open circuit</li> </ol>	<ol style="list-style-type: none"> <li>1. Check the button switch circuit</li> <li>2. Check the AC contactor circuit</li> </ol>
The motor is noisy but won't turn	<ol style="list-style-type: none"> <li>1. Three-phase power supply is missing</li> </ol>	<ol style="list-style-type: none"> <li>1. Stop operation immediately and check whether the main circuit of the motor is broken (phase)</li> </ol>
The motor rotates the worktable does not rise	<ol style="list-style-type: none"> <li>1. Incorrect motor rotation</li> <li>2. Hydraulic oil is insufficient</li> <li>3. Due to transportation and other reasons, the pump is filled with air, resulting in gas blockage</li> <li>4. The relief valve is not working</li> <li>5. The manual unloading valve or electromagnetic unloading valve spool is stuck with dirt</li> <li>6. Oil pump oil seal damage</li> <li>7. The motor runs heavy and shakes, and the outer net of the oil filter is seriously blocked</li> </ol>	<ol style="list-style-type: none"> <li>1. Change motor phase</li> <li>2. Add hydraulic oil</li> <li>3. Remove the moving upward key of the check valve (pay attention to the oil injection) and see the oil flowing out from the hole. Then reinstall the check valve (tighten it).</li> <li>4. Check the sealing of the spool and sealing of the sealing of the overflow valve, clean the valve or replace the damaged sealing ring</li> <li>5. Check the unloading valve and clean the valve core.</li> <li>6. The gear pump can be removed to check and replace the seal ring</li> <li>7. Clean the oil filter</li> </ol>
The rate of ascent is too slow	<ol style="list-style-type: none"> <li>1. Oil pump oil seal damage and oil leakage</li> </ol>	<ol style="list-style-type: none"> <li>1. Ibid</li> </ol>
Jitter at work	<ol style="list-style-type: none"> <li>1. Air in the hydraulic circuit</li> <li>2. The upper joint of the oil pump suction pipe leaks air</li> <li>3. Filter blockage</li> </ol>	<ol style="list-style-type: none"> <li>1. Run exhaust repeatedly up and down.</li> <li>2. Check the connection and sealing condition of oil pump suction pipe</li> <li>3. Clean the oil filter</li> </ol>